



Consommation
et Corporations Canada

Consumer and
Corporate Affairs Canada

Bureau des brevets

Patent Office

Ottawa, Canada
K1A 0C9

(11) (C)	1,293,566
(21)	531,510
(22)	1987/03/09
(45)	1991/12/24
(52)	354-22
C.L. CR.	354-233

(51) INTL.CL.⁵ G06F-15/42

(19) (CA) CANADIAN PATENT (12)

(54) Medical Information System

(72) Beck, Roger P. , U.S.A.
 Castagno, Daniel L. , U.S.A.
 Craig, Robert B., Jr. , U.S.A.
 Davidheiser, Timothy S. , U.S.A.
 Haley, Allen W., Jr. , U.S.A.
 Huff, Stanley M. , U.S.A.
 Radigan, Russell P. , U.S.A.

(73) American Telephone and Telegraph Company , U.S.A.

(30) (US) U.S.A. 862,094 1986/05/12

(57) 16 Claims

Canada

CCA 3254 (10-89) 41

53/510

MEDICAL INFORMATION SYSTEM

Abstract

An information system comprising hospital computer terminals interconnected with a message network.

5 A computer terminal enters record and medical data which is formatted into a data message and transmitted over the message network to each computer terminal. The received record and medical data is modified in accordance with data assigned the receiving computer terminal and recorded

10 in data bases. Patient data entered into computer terminals is recorded in a patient file data base consistent with the modified record and medical data recorded in the computer terminal data bases.

MEDICAL INFORMATION SYSTEM

Technical Field

This invention relates to an information system.

Background of the Invention

5 Hospitals have a number of clinics and departments that serve patients and needs of the hospital. A patient entering a hospital may be admitted by the registration department or through an emergency care unit and assigned a room in an in-patient clinic. Later, the
10 admitted patient may undergo a series of tests that involve the hospital laboratories and specimens may be taken to determine the patient's health. The patient may undergo surgery and spend time in a recovery room or intensive care unit under the constant care of physicians
15 and nursing staff.

The patient, after leaving the recovery room or intensive care unit, may be returned to the originally assigned room or to a room in another in-patient clinic of the hospital. Personal physicians of the patient, along
20 with staff physicians and nurses of the hospital, may prescribe various tests and drugs for care of the patient. Record entries for the patient are maintained at the in-patient clinic nurses station. Various medicines and drugs are obtained from the pharmacy and charge
25 information provided to the financial department. The financial department accumulates patient charges and prepares a bill available at the financial department upon discharge of the patient from the hospital.

30 There may be out-patient clinics where a patient may be admitted for the purposes of receiving hospital services performed by physicians and nurses. The out-patient clinics may prescribe tests and obtain medicines and drugs from the pharmacy. Record entries are prepared



and used by physicians and nurses to provide care for the patient and by the financial department in preparing a bill for services. There may be a records department where records of patients are maintained and archived.

- 5 Hospitals also have medical departments wherein patient records may be maintained by physicians and wherein new medical record forms may be developed. New drugs and medical procedures may be recommended by the medical department for use by the hospital physician and nursing
10 staff.

- Information systems have been developed for hospitals for use in preparing patient bills. Such a type of information system is usually provided on a large computer which is also used for general financial matters
15 such as payroll, accounts receivable and accounts payable. A hospital may also have a medical claim verification and processing system for determining a patient's background, medical and insurance information for use in determining the amount of payment for insurance claims. Some
20 hospitals may also have a computer medical care system for use in the treatment and care of patients. Such systems have a control unit adapted for instructing hospital staff physicians and nurses and advising them to perform diagnostic and therapeutic procedures according to a
25 predetermined plan. There may also be a computer medical system for use in caring for the needs of specific patients and for receiving, storing and reporting test information for an entire patient population.

- A problem arises in that each of these
30 information systems are a stand alone system developed for use by a specific clinic or department of a hospital. It appears that none of these systems have been developed for use by all clinics and departments of a hospital. Accordingly, a need exists for a medical information
35 system interconnecting all of the clinics and departments of a hospital. A need also exists for an information system interconnecting all clinics and departments of a

hospital wherein record and medical data may be entered into the system and made available to all clinics and departments in accordance with specific clinic and department station requirements required to protect record, medical and patient data.

Summary of the Invention

5 The foregoing problems are solved and a technical advantage is achieved by an information system having interconnected user groups of computer terminals each provided with a user protocol for use in conditioning each computer terminal in recording data at the computer terminal in accordance with the user class and user protocol.

10 In accordance with one aspect of the invention there is provided a computer information system having a plurality of interconnected computer terminals each defined by a user class CHARACTERIZED IN THAT said information system comprises means for entering a user protocol into a computer terminal for transmission to each other computer terminal, means for modifying said user protocol
15 at each computer terminal to conform to said user class assigned the computer terminal, and means for conditioning each computer terminal to record and display data entered at the computer terminal in accordance with the computer terminal defined user class and modified user protocol.

20 In accordance with another aspect of the invention there is provided a method of enabling a medical information system having a plurality of interconnected computer terminals for conditioning the computer terminals to accept patient data CHARACTERIZED IN THAT said method comprises the steps of entering record and medical data into one of the computer terminals and recording said record and medical data in record forms files and medical data dictionary data bases of the
25 computer terminal, accessing said recorded record and medical data at predetermined intervals of time and on demand and transmitting said record and medical data to each of the interconnected computer terminals, and modifying said transmitted record and medical data at each computer terminal in accordance with station requirement data assigned the computer terminal and recording said modified record and medical
30 data in the computer terminal forms files and medical data dictionary data bases for use in entering patient data into a patient file data base of the computer terminal consistent with said station requirement data.

Brief Description of the Drawing

The foregoing as well as other objects, features and advantages of the invention will be more apparent from a description of the drawing in which;

5 FIG. 1 is a block diagram of an information system embodying the principles of the invention;

FIG. 2 is an operational chart diagram showing a functional apparatus relationship of clinical and departmental computer terminals used in the information system set forth in FIG. 1; and

10 FIGS. 3, 4, 5 and 6 illustrates a flow chart of the operation of the information system and computer terminals set forth in FIGS. 1 and 2, respectively.

Description of the Invention

15 Referring to FIG. 1 of the drawing, information system 1 set forth therein is intended for use in interconnecting clinics and departments of a hospital in order to share common information modified to clinical and departmental station requirements defined by each computer terminal. For example, financial department 11 may have several minicomputers 114, 115 or a large mainframe computer serving several work areas that may have registration computer terminals 111, billing computer terminals 112 or financial record computer terminals 113.

Financial department computer terminals 111, 112, 113 are interconnected through financial department computers 114, 115 with financial node 110 of interconnection message network 19. Message network 19 may be any one of several
5 different types of networks commonly referred to as local area types of packet networks that transmit data messages between nodes and need not be described in detail for an understanding of the invention.

Each laboratory 12 may have a laboratory
10 computer terminal 121 connected by a laboratory node 120 to message network 19 such that laboratory 12 may exchange information with other laboratories, clinics and departments of the hospital. The hospital may also have a pharmacy 13 with a pharmacy computer terminal 131
15 interconnected by pharmacy node 130 with message network 19. There may also be a specimen clinic 14 having specimen computer terminals 141 for use by the specimen clinic staff and which are interconnected by specimen node 140 with message network 19.

20 Out-patient clinic 18 may have a number of computer terminals 181, 182, 183. Computer terminals, such as out-patient clinic computer terminals 181, 182 and 183, may each be a personal computer provided for use by the physicians and nurses of the out-patient clinic.
25 Each computer terminal 181, 182, 183 of out-patient clinic 18 is interconnected by out-patient node 180 to message network 19.

A record and archive department 15 of the hospital may have a number of computer terminals, such as
30 computer terminal 151, connected to message network 19 via record node 150. The medical department may be provided with personal computer terminals 171, 172 each connected by a medical department node 170 with message network 19. Although any computer terminal may be used to control
35 information system 1, usually one of the medical department's computer terminals, such as computer terminal 171, may be designated as a master computer

terminal and used to enter record form and medical data into information system 1.

Information system 1 may also be interconnected with various data networks by interface node 160 and
5 interface unit 16 so that remote data base systems may be accessed to obtain present and historical medical information.

Main clinics are in-patient clinics 10 wherein medical care is provided by the patient's physician and by
10 the physician and nursing staff of the hospital. Each of the in-patient clinic rooms or beds may be provided with a bedside computer terminal 101, 102, 103, 104 for use by the physicians and nurses attending the patient. A
15 computer terminal such as computer terminal 101 may be a monitor terminal connected with other monitor terminals to a central computer 1000 or may be a personal computer type of computer terminal provided with the functional and operational capabilities of computer 1000. In the present
20 embodiment of the invention, each computer terminal of information system 1, such as the computer terminal 101, is assumed to have the apparatus and functional operational capabilities of computer 1000.

Each computer terminal of information system 1 has a patients file data base 10030 for recording patient
25 data in accordance with record and medical data recorded, respectively, in forms files data base 100112 and medical data dictionary data base 100222. A computer terminal also has a user executive 10013 in combination with security file 10014 and station requirements file data
30 10015. Security file 10014 is unique to each computer terminal and is intended for use in limiting access to information system 1 and to the patient data records in patient file data base 10030. Security file 10014 restricts unauthorized user access to record and medical
35 data recorded in forms files data base 100112 and medical data dictionary data base 100222. Security file 10014 also prevents access to applications software resident in

the computer terminal and prevents unauthorized user access to message network 19.

A user defined class of computer terminals interconnected with message network 19, such as in-patient
5 clinic 10 computer terminals 101, 102, 103, 104, 105, each have a clinical and departmental station requirements file data 10015 that define the operating characteristics of an in-patient clinic computer terminal. Station requirements file data 10015, which have clinic and department
10 requirements data recorded therein, identifies the type of patient data that physicians and nurses may enter into or read out of the group of in-patient computer terminals 101 through 105 while administering to patients of the hospital. Another user defined class of computer
15 terminals, for example pharmacy computer terminal 131, may have a pharmacy station requirements file data 10015 that restricts the entry and reading of patient data to physician prescribed medications. In yet another user class of computer terminals, such as medical department 17
20 computer terminals 171, 172, the medical department station requirements file data 10015 may be sufficiently broad so as to enable a medical staff physician director of the hospital to use a medical department master computer terminal 171 having a broad access to patient
25 data for consultation and diagnosis. Although any computer terminal may be designated a master computer terminal, usually a medical department computer terminal will be designated a master computer terminal wherein medical department station requirements file data 10015
30 will define the operational characteristics of the medical department master computer terminal. The master computer terminal controls the entry of new record and medical data into information system 1 and the type of record and medical data to be recorded into the forms files and
35 medical data dictionary data bases of each computer terminal connected to message network 19.

A bulletin board 10016 located in the memory of each computer terminal identifies types of applications software 10018 available to perform the operational characteristics required of each computer terminal. Data base server 10019 enables an authorized user of each computer terminal to access a patient file data base 10030 used to store patient data as modified by the clinical and departmental station requirements file data 10015 for each computer terminal so that modified patient data may be written into and read from a computer terminal by the authorized user of the computer terminal. Each computer terminal also has a network interface 10017 that serves to interconnect the computer terminal with a node, such as in-patient node 100, of message network 19. Large computer terminals and computers 114 and 115 of financial department 11 may, FIG. 2, have a data backup processor link 1023 wherein data base information of the computer terminal or computer may be saved by a backup unit for security purposes to prevent loss of data.

Each clinic and department computer terminal interconnected with message network 19, FIG. 1, has a medical record subsystem 10011 and medical data subsystem 10022 used to record clinical and departmental station requirements file data 10015 modified record and medical data. Record and medical data modified by the clinical and departmental station requirement file data 10015 are filed in the forms files data base 100112 and medical data dictionary data base 100222 of each computer terminal and is used in connection with entering and reading patient data into and from a computer terminal consistent with the clinical and departmental station requirements file data 10015 modified record and medical data.

Medical record subsystem 10011, FIG. 2, has applications software 100110 that is identified by bulletin board 10016 and which is used in connection with

data base server 100111 and forms files data base 100112 to record and read entered and verified record data. Similarly, medical data subsystem 10022 has applications software 100220 identified by bulletin board 10016 and
5 which is used in connection with data base server 100221 and medical data dictionary data base 100222 to record and read entered and verified medical data. Medical data subsystem 10022 also has a field table 100223 that is used by a computer terminal in entering patient data in patient
10 file data base 10030.

If one computer terminal, for example medical department 17 computer terminal 171, FIG. 1, has been designated as a master computer terminal, then master computer terminal 171 would be provided with a visual
15 editor 10010 for use in entering record and medical data into medical information system 1. Each computer terminal interconnected with message network 19 may be equipped with visual editor 10010 for entering record and medical data into medical information system 1.

20 In the operation of a hospital, it is essential that record and medical data be constantly revised and updated to reflect changes in new medical technology. For example, new surgical, psychoanalysis and therapeutic techniques may be developed for treating patients thereby
25 requiring changes in the format of patient's records and additions to and deletions from medical data recorded in a hospital information system. The computer terminals of information system 1, FIG. 1, are arranged such that record and medical data may be entered into information
30 system 1 by the use of visual editor 10010 of a computer terminal such as medical departmental master computer terminal 171 to condition other computer terminals. Applications software 100110 and 100220, FIG. 2, record the entered record and medical data, via the use of data
35 base servers 100111 and 100221, in forms files data base 100112 and medical data dictionary data base 100232, respectively.

Applications software 10018 accesses the record and medical data recorded in forms files and medical data dictionary data bases 100112, 100222, via bulletin board 10016 and data base servers 100111, 100221, at
5 predetermined intervals of time. Newly recorded record and medical data are formatted by applications software 10018 into record and medical data messages that are transmitted, via network interface 10017 and message network 19, FIG. 1, to each of the medical information
10 system computer terminals.

When the transmitted record and medical data is received at a computer terminal, for example in-patient clinic computer terminal 101, via network interface 10017, FIG. 2, applications software 10018 modifies the received
15 record and medical data in accordance with the in-patient clinic station requirements file data 10015. The modified record and medical data is then recorded, via applications software 10018, bulletin board 10016, applications software 100110, 100220 and data base servers 100111,
20 100221, in forms files data base 100112 and medical data dictionary 100222, respectively.

User executive 10013 enables patient data to be entered into a computer terminal such as in-patient clinic computer terminal 101. Applications software 10018 reads
25 the modified record and medical data recorded in forms files and medical data dictionary data bases 100112, 100222, via data base servers 100111, 100221, applications software 100110, 100220 and bulletin board 10016. The entered patient data is modified and then recorded, via
30 data base server 10019, in patient file data base 10030 consistent with the in-patient clinic station requirements file data modified record and medical data.

Referring to FIGS. 3, 4 and 5 of the drawing, the method of operation enables information system 1 to
35 condition interconnected clinic and department computer terminals to accept patient data. The method comprises the steps 301, 302 of enabling a user 30 of a computer

terminal, such as medical department master computer terminal 171, to enter records and medical data, via visual editor 10010, into computer terminal 171 and verify accuracy of the entered record and medical data.

- 5 Applications software 100110, 100220 accomplishes the steps 303, 304, 305, 401, 402, 403, 404 of recording the entered and verified record and medical data in forms files and medical data dictionary data bases 100112, 100222 by determining if the entered data is record or
10 medical data and then writing the entered record and medical data, via data base servers 100111, 100221, into forms files and medical data dictionary data bases 100112, 100222, respectively, of the computer terminal.

- Each computer terminal or master medical
15 department computer terminal 171 has applications software 10018 that starts a data message transmission sequence 306 to transmit new record and medical data over message network 19 to each computer terminal of information system 1. Start data message transmission
20 sequence 306 operates at predetermined intervals of time defined by time delay 308 or on demand to initiate the sequence of conditioning computer terminals of information system 1. If new record or medical data has been entered into the computer terminal, forms files and medical data
25 dictionary data bases 100112, 100222 are accessed at steps 307, 401, 402, 403, 404, 405, 406, via data base servers 100111, 100221, to read the recorded record and medical data. If the accessed record and medical data is not new, than the computer terminal ends the transmission
30 sequence at steps 45 and 409. When new record and medical data has been entered into the computer terminal, steps 407 and 408 format the record and medical data into a data message which is transmitted on message network 19 to each clinic and department computer terminal.

- 35 Each clinic and department computer terminal at steps 501, 502, 503 receives the transmitted record and medical data message from message network 19 and modifies

the received record and medical data in accordance with the clinical and departmental station requirements file data 10015 assigned each user group of computer terminals. The modified record and medical data is recorded at
5 steps 401, 402, 403, 404, 504, via data base servers 100111, 100221, into the forms files and medical data dictionary data bases 100112, 100222 of each receiving clinic and department computer terminal.

A user 60 located at any of the clinic and
10 department computer terminals, for example, a physician or nurse user of in-patient clinic computer terminal 102, enters at step 601 patient data by user executive 10013, FIG. 2, into computer terminal 102. Applications software 100110, 100220 enables data base servers 100111,
15 100221 at steps 402, 404, 405, 406, 602, to read recorded record and medical data, FIGS. 3, 4, 5 and 6 from forms files and medical data dictionary data bases 100112, 100222 and modify the entered patient data with clinic and department station requirement file data 10015 modified
20 record and medical data. At steps 603, 604, 605, the entered patient data is recorded by writing an entry, via data base server 10019, into patient file data base 10030 so that the patient data recorded in the computer terminal patient file data base 10030 is consistent with the
25 modified record and medical data recorded in the receiving clinic and department computer terminal forms file and medical data dictionary data bases 100112 and 100222, respectively.

Summary

30 It is obvious from the foregoing that the facility, economy and efficiency of a hospital may be substantially enhanced by a information system for use in interconnecting clinics and departments. It is further obvious that a information system wherein medical and
35 patient data may be entered into the system and made available to all interconnected clinics and departments of a hospital in accordance with each specific clinical and

departmental user, security station requirements for protecting the medical and patient data improves the efficiency and operation of the hospital.

While the instant invention has been disclosed
5 within a hospital environment, it is to be understood that such an embodiment is intended to be illustrative of the principles of the invention and that numerous other arrangements may be devised by those skilled in the art without departing from the spirit and scope of the
10 invention.

For example, the medical information system could be used in business applications wherein user groups of interconnected computer terminals may be conditioned by user protocols to condition each computer terminal in
15 accordance with user class data to display and record data.

Claims

1. A computer information system having a plurality of interconnected computer terminals each defined by a user class

- 5 CHARACTERIZED IN THAT
said information system comprises
means for entering a user protocol into a computer terminal for transmission to each other computer terminal,
10 means for modifying said user protocol at each computer terminal to conform to said user class assigned the computer terminal, and
means for conditioning each computer terminal to record and display data entered at the computer terminal
15 in accordance with the computer terminal defined user class and modified user protocol.

2. A medical information system having a plurality of interconnected computer terminals each defined by station requirements file data

- 20 CHARACTERIZED IN THAT
said medical information system comprises
means for entering record and medical data into one of the computer terminals and recording said record and medical data in forms files and medical data bases of
25 the computer terminal,
means for accessing said recorded record and medical data at predetermined intervals of time and transmitting said record and medical data to each of the interconnected computer terminals, and
30 means for modifying said transmitted record and medical data at each computer terminal in accordance with the computer terminal station requirements file data and recording said modified record and medical data in the computer terminal forms files and medical data dictionary
35 data bases for use in entering patient data into a patient file data base of the computer terminal consistent with said station requirement file data and said modified

record and medical data.

3. The medical information system set forth in claim 2

CHARACTERIZED IN THAT

5 said entering means comprises
visual editor means common to each of the
interconnected computer terminals for entering said record
and medical data into each computer terminal and for
verifying the accuracy of said entered record and medical
10 data.

4. The medical information system set forth in claim 3

CHARACTERIZED IN THAT

15 said entering means comprises
means for recording said entered and verified
record and medical data into a forms files data base and
medical data dictionary data base, respectively, of the
one computer terminal.

20 5. The medical information system set forth in claim 4

CHARACTERIZED IN THAT

said accessing means comprises
means for formatting said accessed record and
medical data into a record and medical data message for
25 transmission to each of the computer terminals and on
demand at said predetermined intervals of time.

6. The medical information system set forth in claim 5

CHARACTERIZED IN THAT

30 said modifying means comprises
means located at each computer terminal for
receiving said transmitted record and medical data message
and modifying said record and medical data in accordance
with the station requirement file data assigned the
35 receiving computer terminal.

7. The medical information system set forth in claim 6

CHARACTERIZED IN THAT

said modifying means comprises

5 means for recording said modified record and medical data into the forms files data base and medical data dictionary data base, respectively, of the receiving computer terminal.

10 8. The medical information system set forth in claim 7

CHARACTERIZED IN THAT

said medical information system comprises

means located at the receiving computer terminal for entering said patient data into the receiving computer terminal and recording said entered patient data in said patient file data base of the receiving computer terminal consistent with said modified record and medical data recorded in said receiving computer terminal forms files and medical data dictionary data bases.

20 9. A medical information system having a plurality of computer terminals each interconnected with a network

CHARACTERIZED IN THAT

said medical information system comprises

25 visual editor means common to each computer terminal for entering record and medical data into one computer terminal and for verifying the accuracy of said entered record and medical data,

30 means for recording said entered and verified record and medical data into a forms files data base and medical data dictionary data base, respectively, of the one computer terminal,

35 means common to each computer terminal for accessing said forms files and medical data dictionary data bases and formatting said entered and verified record and medical data into record and medical data messages,

means activated at predetermined intervals of time and on demand for transmitting said formatted record and medical data messages over the network to each of the other computer terminals connected to the network,

5 means located at each computer terminal for receiving said transmitted record and medical data messages and modifying said record and medical data in accordance with station requirements file data assigned the receiving computer terminal,

10 means for recording said station requirements modified record and medical data into a forms files data base and medical data dictionary data base, respectively, of the receiving computer terminal, and

means located at the receiving computer terminal
15 for entering patient data into the receiving computer terminal and recording said entered patient data in a patient file data base of the receiving computer terminal consistent with said station requirements modified record and medical data recorded in said receiving computer
20 terminal forms files and medical data dictionary data bases.

10. A hospital medical information system having a medical department master computer terminal and a plurality of clinic and department computer terminals each
25 interconnected with a message network,

CHARACTERIZED IN THAT

said hospital medical information system comprises

visual editor means located at the master
30 computer terminal for entering record and medical data into the master computer terminal and for verifying the accuracy of said entered record and medical data,

master computer terminal means for recording said entered and verified record and medical data into a
35 forms files data base and medical data dictionary data base, respectively, of the master computer terminal,

master computer terminal means for accessing
said master computer terminal forms files and medical data
dictionary data bases and formatting said entered and
verified record and medical data into record and medical
5 data messages,

master computer terminal means activated at
predetermined intervals of time and on demand for
transmitting said formatted record and medical data
messages over the network to each clinic and department
10 computer terminal connected to the message network,

means located at each clinic and department
computer terminal for receiving said transmitted record
and medical data messages and modifying said record and
medical data in accordance with clinic and department data
15 assigned the receiving clinic and department computer
terminal,

means located at each clinic and departmental
computer terminal for recording said modified record and
medical data into a forms files data base and medical data
20 dictionary data base, respectively, of the receiving
computer terminal, and

means located at the receiving clinic and
department computer terminal for entering patient data
into the receiving clinic and department computer terminal
25 and recording said entered patient data in a patient file
data base of the receiving clinic and department computer
terminal consistent with said modified record and medical
data recorded in said receiving clinic and department
computer terminal forms files and medical data dictionary
30 data bases.

11. A method of enabling a medical information
system having a plurality of interconnected computer
terminals for conditioning the computer terminals to
accept patient data

35 CHARACTERIZED IN THAT

said method comprises the steps of
entering record and medical data into one of the
computer terminals and recording said record and medical
data in record forms files and medical data dictionary

5 data bases of the computer terminal,

accessing said recorded record and medical data
at predetermined intervals of time and on demand and
transmitting said record and medical data to each of the
interconnected computer terminals, and

10 modifying said transmitted record and medical
data at each computer terminal in accordance with station
requirement data assigned the computer terminal and
recording said modified record and medical data in the
computer terminal forms files and medical data dictionary
15 data bases for use in entering patient data into a patient
file data base of the computer terminal consistent with
said station requirement data.

12. The medical information system enabling
method for conditioning interconnected computer terminals
20 to accept patient data set forth in claim 11

CHARACTERIZED IN THAT

said entering step comprises the steps of
exercising a visual editor common to each of the
interconnected computer terminals for entering said record
25 and medical data into each computer terminal and for
verifying the accuracy of said entered record and medical
data, and

recording said entered and verified record and
medical data into a forms files data base and medical data
30 dictionary data base, respectively, of the one computer
terminal.

13. The medical information system enabling
method for conditioning interconnected computer terminals
to accept patient data set forth in claim 12

35 CHARACTERIZED IN THAT

said accessing step comprises the steps of
formatting said accessed record and medical data
into record and medical data messages, and
transmitting said formatted record and medical
5 data messages to each of the computer terminals at said
predetermined intervals of time.

14. The medical information system enabling
method for conditioning interconnected computer terminals
to accept patient data set forth in claim 13

10

CHARACTERIZED IN THAT

said modifying step comprises the steps of
receiving at each computer terminal said
transmitted record and medical data messages, and
modifying said record and medical data in said
15 record and medical data messages in accordance with said
station requirement data assigned the receiving computer
terminal.

15. The medical information system enabling
method for conditioning interconnected computer terminals
20 to accept patient data set forth in claim 14

CHARACTERIZED IN THAT

said modifying step further comprises the steps
of recording said station requirement modified record and
medical data into a forms files data base and medical data
25 dictionary data base, respectively, of the receiving
computer terminal, and

entering said patient data into the receiving
computer terminal and recording said entered patient data
in said patient file data base of the receiving computer
30 terminal consistent with said station requirement modified
record and medical data recorded in said receiving
computer terminal forms files and medical data dictionary
data bases.

16. A method of enabling a hospital medical
35 information system having a medical department master
computer terminal and a plurality of clinic and
departmental computer terminals each interconnected with a

message network for conditioning the clinic and departmental computer terminals to accept patient data

CHARACTERIZED IN THAT

said method comprises the steps of

5 entering record and medical data into the master computer terminal and verifying the accuracy of said entered record and medical data,

10 recording said entered and verified record and medical data in a forms files data base and medical data dictionary data base, respectively, of the master computer terminal,

15 accessing said master computer terminal forms files and medical data dictionary data bases and formatting said entered and verified record and medical data into record and medical data messages,

transmitting said formatted record and medical data messages over the message network to each clinic and department computer terminal connected to the message network,

20 receiving said transmitted record and medical data messages at each clinic and department computer terminal and modifying said record and medical data in accordance with clinical and departmental data assigned the receiving clinic and department computer terminal,

25 recording said modified record and medical data into a forms files data base and medical data dictionary data base, respectively, of the receiving clinic and department computer terminal, and

30 entering patient data into each receiving clinic and department computer terminal and recording said entered patient data in a patient file data base of the receiving clinic and department computer terminal consistent with said modified record and medical data recorded in said receiving clinic and department computer terminal forms files and medical data dictionary data bases.

35



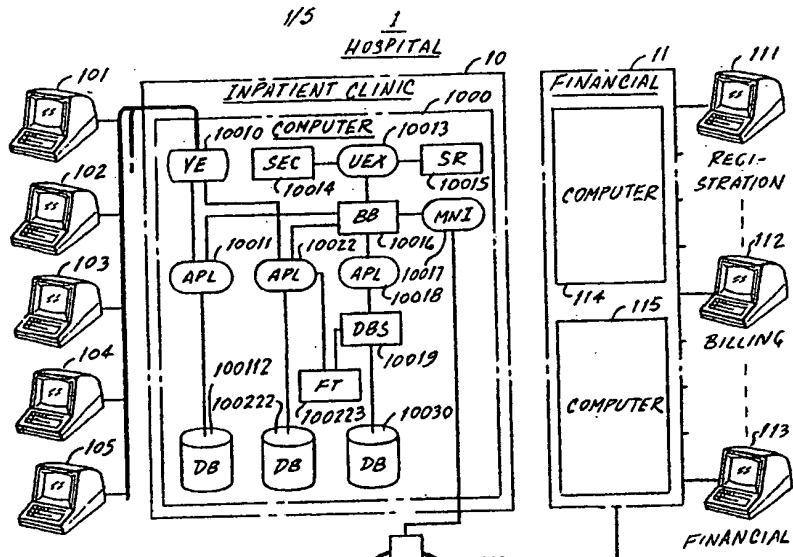
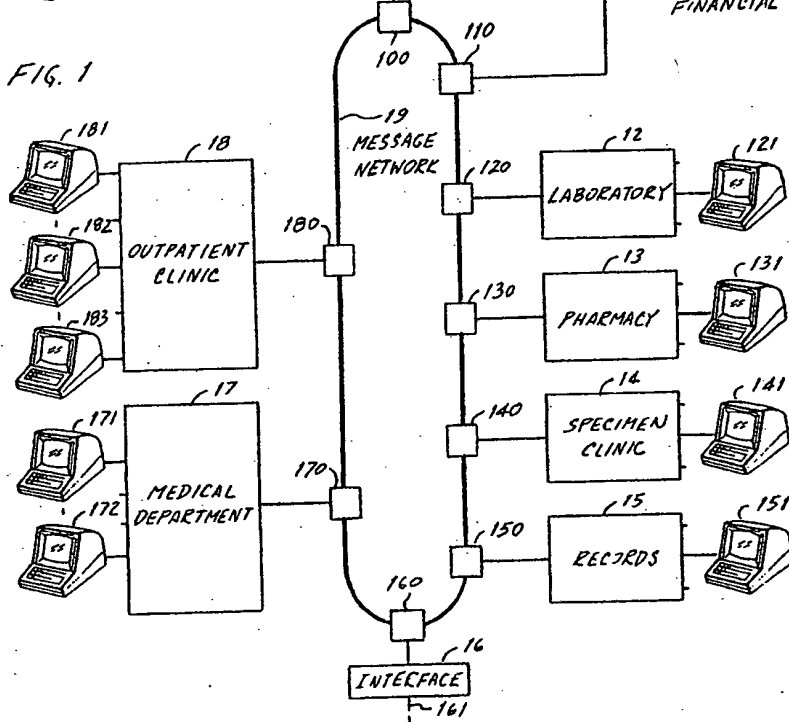

FIG. 1



Kurdy, Shapiro,
Eales, Cohen

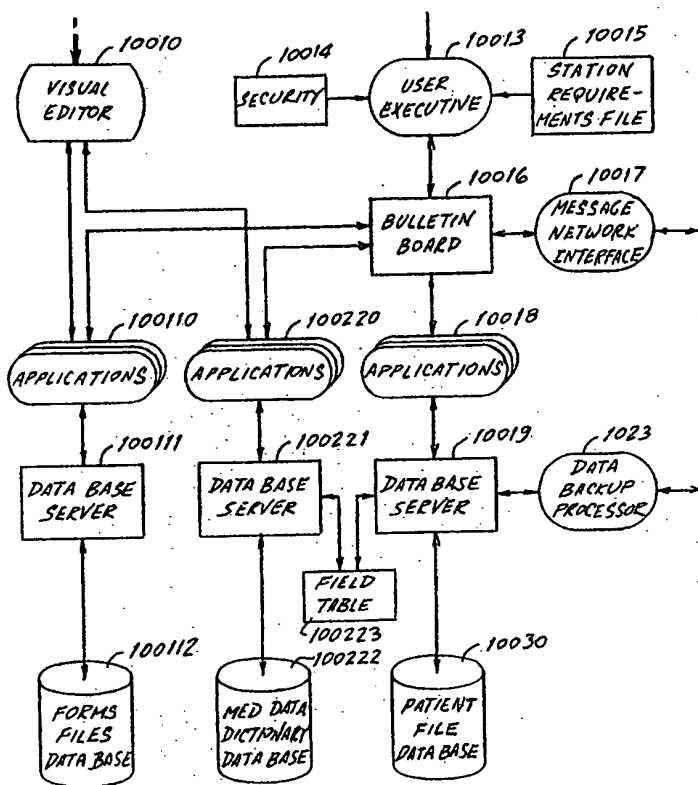
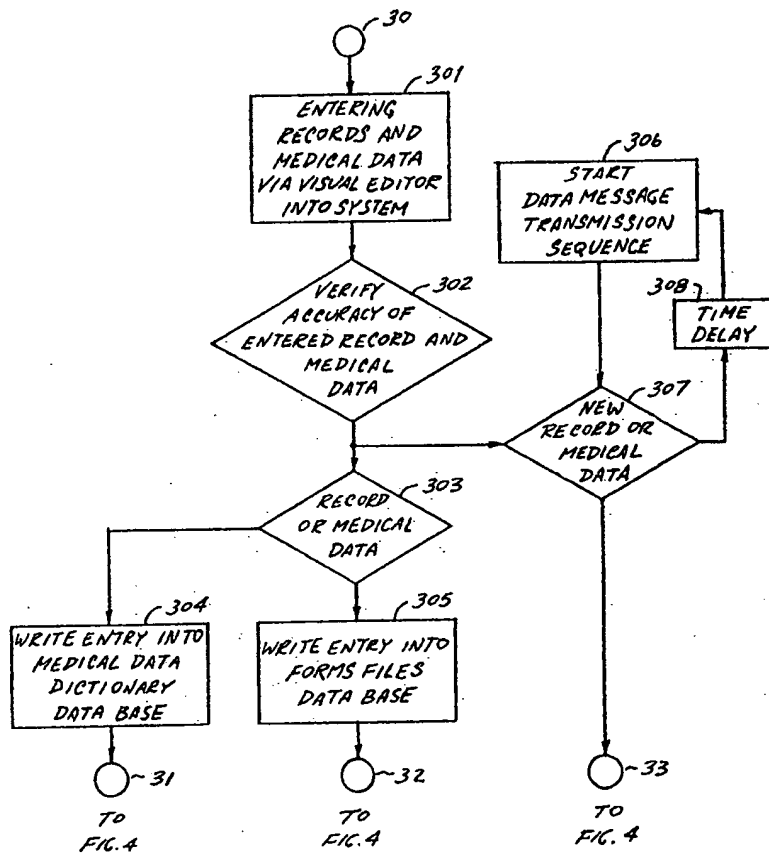

FIG. 2

Kirby, Shapiro,
Eidos, Cohen

FIG. 3



Kirby, Sapiro,
Entes, Cohen

4/5 FIG. 4

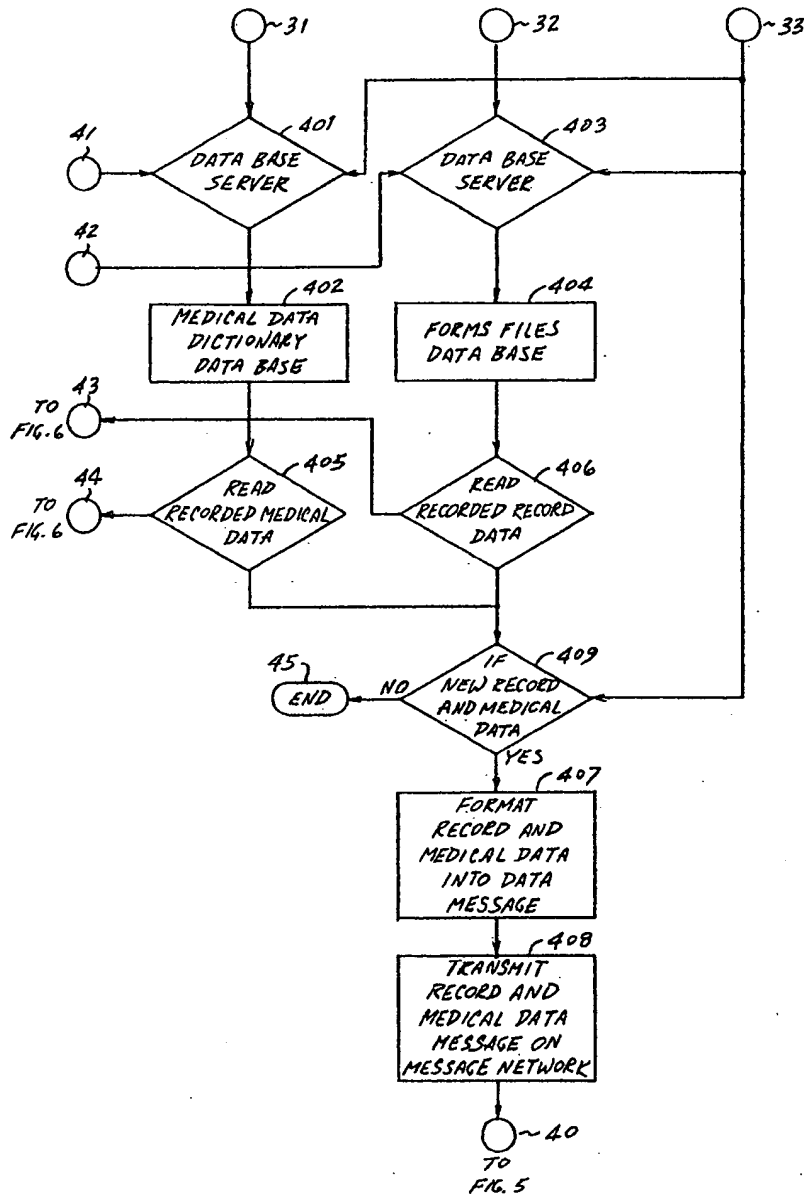

Kirby, Sharpin,
Euler, Cohen

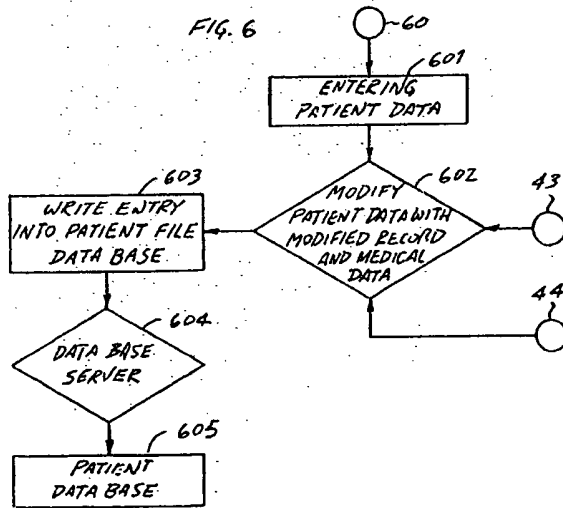
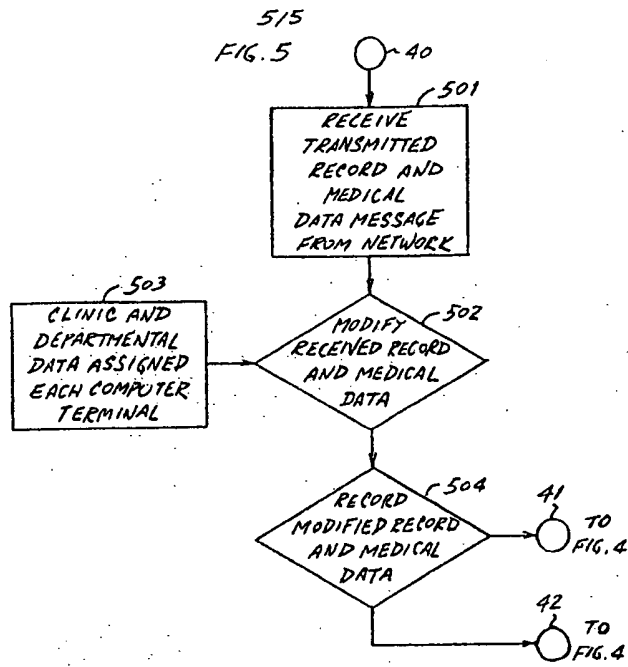

Kirby, Shapiro,
Eades, Cohen

**This Page is Inserted by IFW Indexing and Scanning
Operations and is not part of the Official Record**

BEST AVAILABLE IMAGES

Defective images within this document are accurate representations of the original documents submitted by the applicant.

Defects in the images include but are not limited to the items checked:

- BLACK BORDERS**
- IMAGE CUT OFF AT TOP, BOTTOM OR SIDES**
- FADED TEXT OR DRAWING**
- BLURRED OR ILLEGIBLE TEXT OR DRAWING**
- SKEWED/SLANTED IMAGES**
- COLOR OR BLACK AND WHITE PHOTOGRAPHS**
- GRAY SCALE DOCUMENTS**
- LINES OR MARKS ON ORIGINAL DOCUMENT**
- REFERENCE(S) OR EXHIBIT(S) SUBMITTED ARE POOR QUALITY**
- OTHER:** _____

IMAGES ARE BEST AVAILABLE COPY.

As rescanning these documents will not correct the image problems checked, please do not report these problems to the IFW Image Problem Mailbox.